

SEEPEX.
ALL THINGS FLOW

SUPERIOR RANGE AND DEPTH OF SOLUTIONS PRODUCT GROUPS AND RANGES

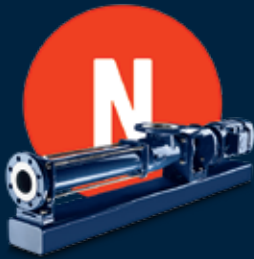

IDEAL CONVEYING SOLUTIONS FOR EVERY CUSTOMER.

SEEPEX progressive cavity pumps, macerators and control systems are used wherever thin to highly viscous, aggressive or abrasive media with or without solids must be conveyed with minimal pulsation. Our portfolio comprises a variety of market-specific product groups with high-performance ranges, which enable a customized solution for every customer.

OUR PORTFOLIO

MARKET-SPECIFIC PRODUCT GROUPS WITH HIGH-PERFORMANCE RANGES

CUSTOMER-SPECIFIC SOLUTIONS STRONG INNOVATION

REDUCED LIFE CYCLE COSTS

HIGH ENERGY EFFICIENCY

SEEPEX was founded in 1972 in Bottrop, Germany and is known today as the leading worldwide specialist in progressive cavity pump technology, represented in over 70 countries. Numerous patents demonstrate how SEEPEX is a leader in innovation – continuously developing new products and technologies. These developments translate into high energy efficiency and drastically reduced life cycle costs.

Environmental engineering, renewable energy, food and beverage, agriculture, textile industry and many more: SEEPEX pumps operate reliably in all of the most significant industries. The experts at SEEPEX place great emphasis on intensive customer consultancy, using a holistic approach to examine the specific processes of customers and find the ideal solution for the respective application.

Additionally, SEEPEX offers a comprehensive range of services – for a long and economical pump life. With superior service and innovative design, SEEPEX reaches the ultimate goal: the best solution for the customer. All things flow.

MODULAR, INNOVATIVE AND FOR ANY APPLICATION.

SEEPEX makes progressive cavity pumps with a distinctive feature: The conveying elements are formed by the intersecting geometries of a helical rotor and a double internal helical stator. Each pump is manufactured using a modern quality management system with all of the most up-to-date technologies – designed according to the unique requirements of each industry sector, application and media.

WIDE APPLICATION RANGE

The SEEPEX portfolio comprises market-specific product groups with high-performance ranges – suitable for handling abrasive and aggressive products with all degrees of viscosity and containing a high solids content. They can be used on fluids at extreme temperatures and can transport products with a capacity of 0.06 l/h up to 500 m³/h (0.016 USGPH–2,200 USGPM), independent of discharge pressure or the DS content of the product. Differential pressures of up to 48 bar (700 psi), and higher in special cases, are available.

GENTLE, PRECISE AND TROUBLE-FREE

Handling sensitive products often requires a pump with specific features such as low shear rates with minimum internal slippage, accurate metering/flow and minimal pulsation. SEEPEX pumps incorporate all these important features. Additionally, the cavities within the pump can progress from suction to discharge without changing shape and have no check valves to clog.

HIGH SUCTION LIFT CAPABILITIES

Typical for all SEEPEX pumps with a suction housing: Excellent self-priming characteristics and reliable operations – even on gaseous liquids – are possible up to 9 m (29.5 ft.).

VERSATILE

Integration of a SEEPEX pump is easy—they can be installed horizontally, vertically or in almost any position. Pump flow is reversible with shaft rotation and optional open hoppers and feeding arrangements can assist non-flowable products into the pumping elements – the rotor/stator.

SERVICE-FRIENDLY

The drive shaft plug-in connection, universal joints, sealing arrangements and external flange with thru-bolt construction as well as SCT all reflect the guiding SEEPEX principle – ultimate service-friendly design.

ECONOMICAL

SEEPEX guarantees state-of-the-art products, the highest quality of all components, optimized design and manufacturing capabilities – resulting in long pump life and low operating costs.

CAPACITIES

FROM 0.06 L/H TO 500 M³/H (0.016 USGPH TO 2,200 USGPM)

DIFFERENTIAL PRESSURES

UP TO 96 BAR (1400 PSI)

TEMPERATURES

BETWEEN -20°C AND +180°C (0-360°F)

HIGH SUCTION LIFT CAPABILITIES

UP TO 9 M (29.5 FT.)

SCT – SMART CONVEYING TECHNOLOGY.



REDUCED MAINTENANCE TIME
BY UP TO 85%

LONGER LIFE SPAN
UP TO 200%

LIFE CYCLE COSTS
SIGNIFICANTLY REDUCED

DUE TO LOWER ENERGY REQUIREMENTS
HIGH EFFICIENCY

Smart Conveying Technology (SCT) means faster maintenance as the time taken to replace the rotor and stator can be reduced by up to 85%, less downtime and significantly reduced life cycle costs.

The patented award winning design of SCT enables the rotor/stator sealing line to be adjusted to suit the application and to compensate for wear – leading to more than double the lifetime of the rotor and stator. SEPEX pumps with SCT are successfully utilized in virtually all industries, applications and media.

These pumps can be equipped with Smart Seal Housing (SSH). The split SSH allows the stationary counter ring to be removed through the lantern for complete replacement of the mechanical seal. It is no longer necessary to laboriously remove the suction casing and piping, therefore saving time and maintenance costs.

PROPERTIES AND BENEFITS

- Increased productivity, reduced downtime
- Reduction in maintenance time by up to 85%
- Integrated retensioning device resulting in up to 200% increase of rotor and stator life
- Lighter components allowing faster maintenance and assembly/disassembly with minimal manpower
- SSH allows quick maintenance and easy replacement of the mechanical seal
- High efficiency due to lower energy requirements
- Simple maintenance without the need for special tools
- Less space required for installation and essential maintenance as suction and discharge pipework remain in place
- Environmentally friendly as components can easily be recycled

SCT VARIATIONS

This innovative cutting-edge technology can be adapted to meet very specific customer requirements. SCT is available in two versions: 1-stage for pressures up to 4 bar and 2-stage for pressures up to 8 bar. Both pumps offer a wide range of features and benefits.

FEATURES

- Two individual rubber stator halves
- Smart Rotor with quick release geometry
- Rotor and stator sealing line can be adjusted to suit the application
- Lower power requirement
- Higher efficiency
- Readjustable when wear occurs
- Increased component life due to readjustability
- No special tools are required
- Reduced maintenance time
- Double plug and play power train
- Reduced risk of ragging
- Patented solution

PRESSURE, 1-STAGE
**UP TO 4 BAR
(60 PSI)**

PRESSURE, 2-STAGE
**UP TO 8 BAR
(120 PSI)**

1-STAGE

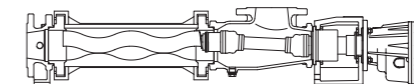

2-STAGE

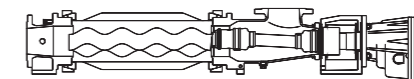

N – STANDARD PUMP.



CONVEYING CAPACITY
**UP TO 500 M³/H
(2,200 USGPM)**

PRESSURE
**UP TO 96 BAR
(1400 PSI)**

Product group N pumps are the basis for all SEEPEX progressive cavity pumps. They can be applied in virtually all industrial sectors – for conveying thin to viscous media, with or without solids – and are available with various rotor/stator geometries, ensuring the pump’s economical operation.

PROPERTIES AND BENEFITS

- 2 ranges
- Various rotor/stator geometries (conventional, 6L, Tricam)
- Minimal pulsation, uniform flow
- High self-priming capabilities even with a mixture of liquid and air/gas up to a 9 m (29.5 ft.) water column
- Low shear rates
- Numerous installation options
- Large spherical entrance port
- Reversible rotation and flow
- Variable speed, flow is directly related to pump speed

BN RANGE

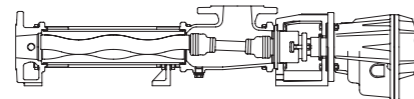

NS/N RANGE

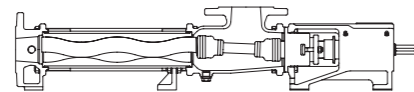

D – METERING PUMP.



CONVEYING CAPACITY
**0.06–1,000 L/H
(0.016–264 USGPH)**

PRESSURE
**UP TO 24 BAR
(350 PSI)**

SEEPEX metering pumps have highly repeatable accuracy. They’re used to handle thin to highly viscous products that can be entrained with or without solids and may be corrosive, all with low pulsation and to the exact drop.

PROPERTIES AND BENEFITS

- 6 ranges
- Simple interchangeability due to their modular construction
- Infinite turn down
- Minimal pulsation, no pulsation dampers required
- Constant flow, independent of pressure
- Low shear characteristics
- High metering accuracy
- Valveless flow control
- No check valves, no gas locking or blocking by solids
- Drive options and control systems available that allow user-friendly metering applications

MD RANGE

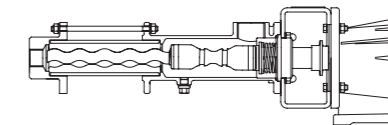

MDP RANGE

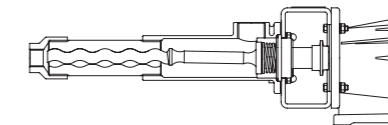

MDC RANGE

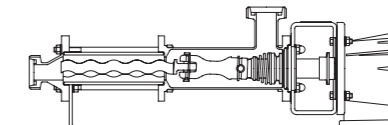

MDTC RANGE

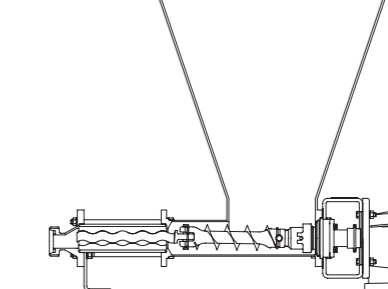

MDF RANGE

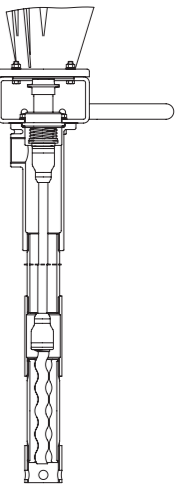

MDT RANGE

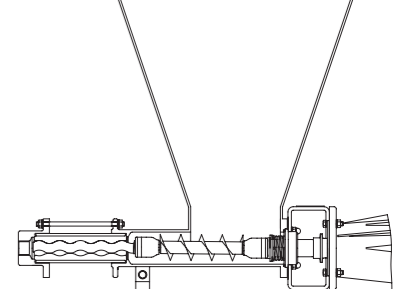

T – OPEN HOPPER PUMP.



CONVEYING CAPACITY
**UP TO 500 M³/H
(2,200 USGPM)**

PRESSURE
**UP TO 36 BAR
(525 PSI)**

SEEPEX open hopper pumps handle viscous to semi-solid products with low or no flowability. They come in nine ranges with multiple variations within each range and are suitable for nearly all industrial sectors.

PROPERTIES AND BENEFITS

- Open hopper and auger feed screw design
- Optimum product handling: open hopper and auger feed screw adjustable for each processing task
- Easy maintenance due to quick access to the joints and plug-in connection
- BTM range pumps incorporate cutting knives for chopping and crushing of the pumped product

BTQ RANGE

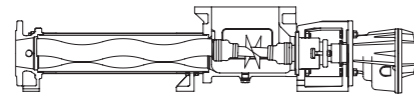

BTHE/BTH RANGE

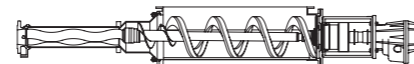

BT RANGE

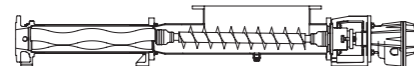

BTES RANGE

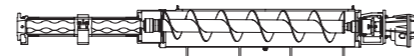

BTM RANGE

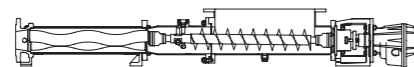

BTEI RANGE

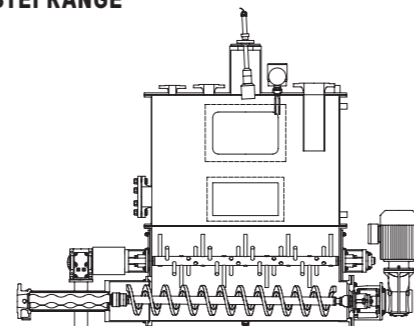

BTVE RANGE

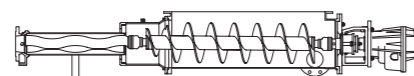

BTI RANGE

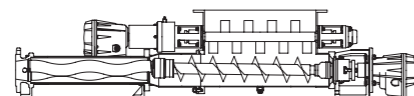

T – BTEX RANGE FOR HARSH APPLICATIONS

CONVEYING CAPACITY
**20–80 M³/H
(90–350 USGPM)**

PRESSURE
**UP TO 8 BAR
(120 PSI)**

SEEPEX BTEX range progressive cavity pumps with their robust design and reinforced components are used in extreme applications in the agriculture and biogas industries. In these applications, the conveyed products can contain solids like stones, pieces of wood or metal parts. During the pumping process, this debris is separated from the media in the hopper/compression housing unit and can be easily removed via the large inspection openings.

A significant feature is the removable compression housing, which greatly simplifies maintenance. Depending on the application, the connections in the hopper/compression housing can be used for feeding the liquid during mixing.

Available options include dry running protection, pressure monitoring and level control.

PROPERTIES AND BENEFITS

- Robust components for harsh applications
- Large cross sections
- Foreign solids are separated within the special hopper design
- Large inspection openings allow for easy removal of any separated solids
- The high volume feed auger promotes thorough mixing of solid and liquid fermentation products
- Removable compression housing ensures quick and easy maintenance

BTEX RANGE



CS – FOOD GRADE PUMP.



SEPEX food grade pumps of product group CS: Used where cleanliness, sterilization and hygiene are of the utmost importance in the food, beverage, pharmaceutical, cosmetics and personal care industries. CS pumps satisfy the highest requirements with regard to gentle conveying, sanitation, cleaning and sterilization. The pumps are designed according to 3-A Sanitary Standards (USA) and comply with EHEDG (BCFH range) and FDA guidelines.

PROPERTIES AND BENEFITS (DEPENDING ON PUMP RANGE)

- CIP/SIP cleaning
- Proven hygienic mechanical seals
- FDA compliant and 3-A approved components
- Easy, quick maintenance of the flexible titanium shaft (Flexrod) due to removable rotor and plug-in shaft connection (BCFH and BCF range)
- EHEDG certified (BCFH range)
- Easy to service, no special tools required
- Particularly gentle pumping
- Easily pumps thin to highly viscous materials
- Stable conveying capacity and pressure
- Variable speed, flow rate is directly proportional to pump speed

CONVEYING CAPACITY
30 L/H-130 M³/H
(0.132-572 USGPM)

PRESSURE
UP TO 24 BAR
(350 PSI)

BCFH RANGE

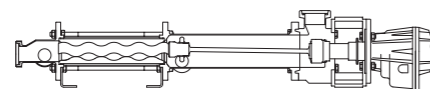

BCSB RANGE

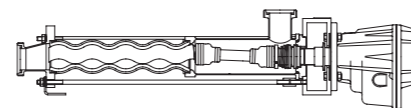

BCF RANGE

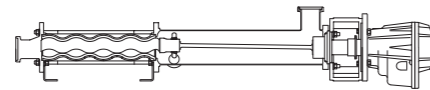

BTCS RANGE

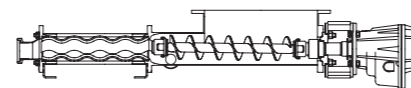

BCSO RANGE

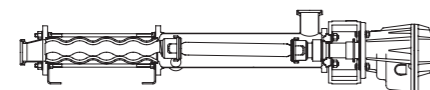

E – SEMI-SUBMERSIBLE PUMP.



SEPEX semi-submersible pumps drain full containers, pits, basins and barrels. They can convey abrasive or corrosive products with thin to high viscosity. Custom-built for the application, they are easy to maintain and have low operating costs. Overall, our semi-submersible pumps are a cost-effective alternative to other pump systems.

PROPERTIES AND BENEFITS

- BE range available in four different immersion variations for individual adaption to the application
- Minimal pulsation, uniform flow
- Variable submersible depths
- Increases the available NPSH value (Net Positive Suction Head)
- The pump can be installed in a “can” to further increase the NPSHA
- Can be installed in a closed system (complies with environmental regulations)

CONVEYING CAPACITY
30 L/H-300 M³/H
(0.132-1,320 USGPM)

PRESSURE
UP TO 12 BAR
(175 PSI)

BE RANGE
 SEMI-SUBMERSIBLE
 VARIANT U

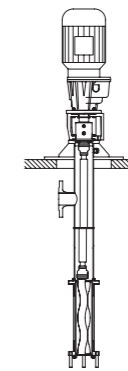

BE RANGE
 SEMI-SUBMERSIBLE
 VARIANT O

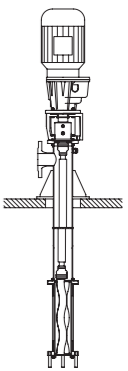

BE RANGE
 SEMI-SUBMERSIBLE
 VARIANT K

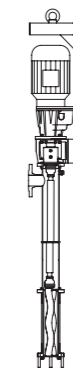

BE RANGE
 SEMI-SUBMERSIBLE
 VARIANT W

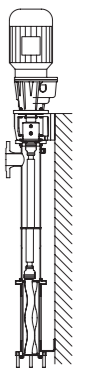

W – WOBBLE PUMP.



CONVEYING CAPACITY
UP TO 10 M³/H
(44 USGPM)

PRESSURE
UP TO 4 BAR
(60 PSI)

SEEPEX wobble pumps work reliably in many industry sectors. They efficiently transfer liquids of all viscosities, even with a high proportion of solids. In contrast to conventional progressive cavity pumps they have a rotating unit with only one joint, which is why they ‘wobble’.

PROPERTIES AND BENEFITS

- Rotating unit with only one joint
- Easy to maintain and economical due to the simple pump design
- Quick and inexpensive replacement of the conveying elements due to a rotating unit with only one joint
- Space-saving via a short, compact design with directly flange-mounted drive (block type)
- BW range with flexible stator secured on one side

BW RANGE

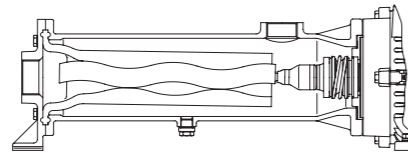

M – MACERATOR.



FLOW RATE
2–150 M³/H
(8.8–660 USGPM)

SEEPEX macerators cut and chop solid and fibrous material in pumped product. This increases operational safety, protects downstream equipment and reduces operating costs. Our macerators work in municipal and industrial wastewater sectors as well as in other industrial services.

PROPERTIES AND BENEFITS

- Controlled macerating due to variable output speeds and shear plates with different-sized openings
- Easy maintenance due to simple replacement of the entire cutter head assembly (cartridge)
- Lower energy consumption compared to alternative macerating technologies
- Two ranges with two sizes each
- I range – Inline design: Direct attachment to the SEEPEX pump or in a compact pipeline
- U range – Universal design: Installation either on a vertical pipeline or supply tank with direct connection to a SEEPEX pump, available in stainless steel construction

U RANGE WITH SOLIDS SEPARATOR

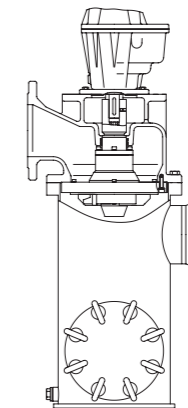

I RANGE

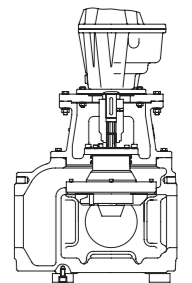



CO – CONTROL SYSTEMS.

SEPEX control systems offer individualized conveying solutions, specific to customer processes. Standard functions are used to protect the pump and ensure reliability. We are a specialized source for standard or customized systems – from the development stage, to pump installation and start-up.

PROPERTIES AND BENEFITS

- Proprietary solutions for lime mixing into biosolids, feeding filter presses, load cell or level sensor operation of cake pumps and boundary layer injection systems
- Standardized control functions and electronics
- Network-capable compact control systems
- Development of customer-specific solutions
- Easy integration with a customer's existing DCS or SCADA system
- Customer-specific solution: SEPEX can customize a control system for every unique application. Contact us for a best fit solution offer.

SWITCH CUPBOARD

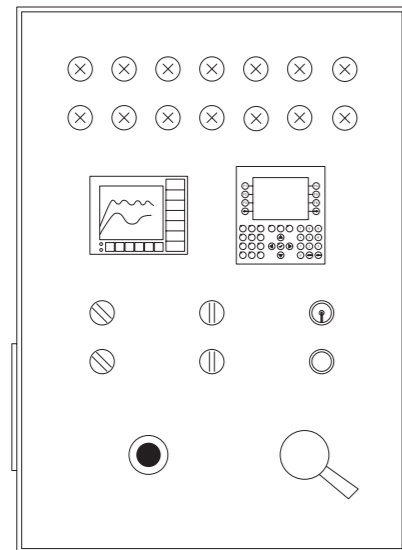

CONTROL MODULE

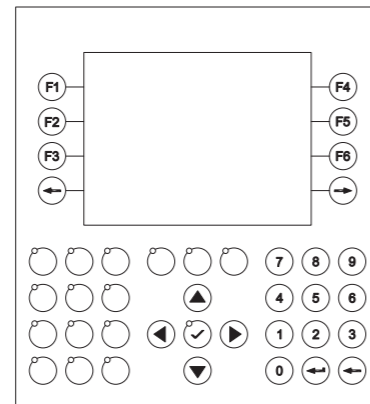

CONVEYING SOLUTIONS FOR ANY APPLICATION.

SEPEX serves a large number of markets worldwide and provides the optimal pump solution for almost any industrial and commercial application – including yours!

PRODUCT GROUPS	SCT	N	CS	T	D	E	W	M	CO
ENVIRONMENTAL TECHNOLOGY									
Domestic wastewater treatment	•	•		•	•	•	•	•	•
Industrial wastewater treatment	•	•		•	•	•	•	•	•
Flocculant metering	•	•			•	•			•
Sludge dewatering	•	•		•			•		•
Chemical dosing	•	•			•	•			•
Flue gas desulfuration	•	•		•			•		•
Oil-water separation	•	•			•	•	•		•
UTILITIES/DISPOSAL									
Freshwater conditioning	•	•		•	•		•		•
Transport of landfill drainage water	•	•			•	•	•		•
Chemical dosing	•	•			•	•			•
GALVANIC									
Chemical dosing	•	•			•	•			•
Disposal of process waste	•	•		•	•	•	•	•	•
FOOD/BEVERAGE INDUSTRY									
Dairy	•	•	•		•				•
Processed fruit and beverages	•	•	•	•	•	•	•		•
Wine production	•	•	•	•	•	•	•		•
Processed vegetables and meat	•	•	•	•	•	•	•		•
Breweries	•	•	•	•	•	•	•		•
PHARMACEUTICAL /COSMETIC INDUSTRY									
Dryer feeding	•	•			•	•	•		•
Metering of additives	•	•	•	•	•	•			•
Filling of end-products	•	•	•	•	•	•			•
Metering and filling controls	•	•	•		•	•			•
FISH INDUSTRY									
Fish meal production	•	•		•			•		•
Fish processing	•	•	•	•	•	•	•	•	•
Fish feeding	•	•		•	•	•	•	•	•
Fish transportation	•	•		•		•	•	•	•
PETROCHEMICAL/OIL PRODUCTION/OFFSHORE									
Bilge-pumping	•	•				•	•		•
Oil-water separation	•	•				•	•		•
Transportation of waste water and excrements	•	•			•	•	•	•	•
Drilling mud treatment	•	•		•	•	•	•		•
Drainage and fire fighting	•	•		•	•	•	•		•
Production of chemicals	•	•		•	•	•	•		•
MINING									
Auxiliary dewatering stations	•	•				•	•		•
Dewatering	•	•		•		•	•		•
Dust-removal	•	•				•	•		•
Flocculant metering	•	•		•	•	•	•		•
Pressure filter feeding	•	•				•	•		•
Back filling and grout	•	•		•		•	•		•

PRODUCT GROUPS	SCT	N	CS	T	D	E	W	M	CO
PULP AND PAPER INDUSTRY									
Stock preparation	•	•		•	•	•	•	•	•
Paper/cardboard production	•	•		•	•	•	•	•	•
Coating processing	•	•			•		•		•
Adhesive and pigment processing	•	•			•		•		•
Coater feed	•	•					•		•
Metering of chemicals	•	•			•				•
Wastewater treatment	•	•		•	•	•	•	•	•
DYEING INDUSTRY									
Metering and filling of colors	•	•	•	•	•	•			•
Component metering	•	•	•	•	•	•			•
Latex foaming	•	•	•		•		•		•
Wastewater treatment	•	•		•	•	•	•	•	•
SHIPS									
Bilgewater handling	•	•				•	•		•
Oil-water separation	•	•			•	•	•		•
Liquid-mud transport	•	•							•
Waste disposal	•	•		•		•	•	•	•
TEXTILE INDUSTRY									
Dye metering	•	•	•	•	•	•			•
Transport of printing ink	•	•		•	•	•	•		•
Feeding of Latex coaters	•	•			•	•	•		•
AUTOMOTIVE/EQUIPMENT									
Wax removal	•	•			•	•	•		•
Mobile dewatering	•	•		•	•	•	•		•
Transport of sealing compounds and protective coatings	•	•		•	•	•	•		•
Waste oil disposal	•	•		•	•	•	•		•
Paint and enamel processing	•	•			•	•	•		•
BUILDING INDUSTRY									
Plaster and gypsum	•	•		•			•		•
Concrete coloring	•	•			•	•	•		•
Tunnel grout	•	•		•			•		•
Wastewater/sludge treatment	•	•			•	•	•	•	•
Dewatering	•	•				•	•		•
WOOD PROCESSING									
Production of partical and MDF boards	•	•				•	•	•	•
Lime metering	•	•				•	•		•
Metering of additives	•	•				•	•		•
CHEMICAL/BIOCHEMICAL INDUSTRY									
Polymer production	•	•	•	•	•	•	•		•
Metering of additives	•	•	•	•	•	•	•		•
Processing of reaction agents	•	•	•	•	•	•	•		•
Dispersion handling	•	•	•	•	•	•	•		•
SUGAR INDUSTRY									
Processing of sugar cane and beets	•	•		•		•	•		•
Diffusion, saturation, thickening	•	•		•		•	•		•
Crystallization	•	•		•		•	•		•
Centrate	•	•		•		•	•		•
Wastewater treatment	•	•		•	•	•	•	•	•
CERAMIC INDUSTRY									
Handling of suspensions	•	•		•			•		•
Metering of additives	•	•			•				•
AGRICULTURE									
Feeding plants	•	•		•	•	•	•		•
Liquid manure transportation	•	•		•	•	•	•	•	•
Biogas plant	•	•		•	•	•	•	•	•
Irrigation systems	•	•					•		•

SEEPEX: SUPERIOR SYSTEM SOLUTIONS.

SEEPEX is not only well known as leader in the manufacture of progressive cavity pumps, but also as an expert in the design and supply of customized fluid/product-handling solutions. The highly qualified SEEPEX engineers are very professional – demonstrating in-depth knowledge about pumps, their applications and the industry sectors they support. They really try to understand a customer's problem and then create innovative engineering solutions that bring results.

SEEPEX progressive cavity pumps and accessories include piping, fittings and instrumentation as well as electronic controllers. All optimized and integrated for each specific application. We consider the complete engineering task, including documentation and project planning.

FOR EXAMPLE, SEEPEX SYSTEM SOLUTIONS INCLUDE:

- Pump systems for specific metering applications including PLC controllers and instrumentation
- Assembly of one or more pumps on special skids with associated pipe work
- Process controllers and control cabinets
- Transition hoppers and handling systems for dewatered sludge (cake pump systems)
- Pumps with engine or hydraulic drives on portable skids
- Pumps on trolleys or trailers

Additionally, we offer complete post-sale portfolios – including installation and commissioning, with a full range of services to support the pump throughout the complete life cycle.

SEEPEX.
ALL THINGS FLOW

SEEPEX GmbH

macxa.com.vn | macxa.vn